

Indoor Unit Operation & Installation Manual

AD052MSERA(H)

AD072MSERA(H)

AD092MSERA(H)

AD122MSERA(H)

AD162MSERA(H)

AD182MSERA(H)

AD242MSERA(H)

- Please read this manual carefully before using
- Keep this operation manual for future reference

Original instructions

User Manual

MRV series multiple air conditioning systems adopt the consistent running mode, by which, all indoor units can only be heating or refrigerating operation at the same time. To protect the compressor, the air conditioning unit should be powered on for over 12 hours before using it.

All indoor units of the same refrigerating system should use the unified power switch to ensure that all indoor units are in the state of being powered on at the same time during the operation of air conditioner.

Your air conditioner may be subject to any change owing to the improvement of Haier products.

Product Features:

- 1.Low static pressure air conditioners for the indoor units of this series;
- 2.The built-in installation to save space;
- 3.Automatic display of fault detection;
- 4.Brushless DC Motor, more energy-efficient;
- 5.Five-grade wind speed, with quiet mode operation;
- 6.Wider range of ESP: 0-30Pa;
- 7.Central control function (optional from our company);
- 8.The air conditioner is provided with the function of compensation for power supply. During operation, when the power supply fails emergently and resumes again, the air conditioner returns to the working condition before power failure, if provided with compensation function.
- 9.Now this indoor unit only has wired controller function, the indoor unit that has remote controller function need to set in factory especially.

Operating Range of Air Conditioner

Cooling dry	Indoor	Max.	DB: 32°C WB: 23°C
		Min.	DB: 18°C WB: 14°C
	Outdoor	Max.	DB: 43°C WB: 26°C
		Min.	DB: -5°C
Heating	Indoor	Max.	DB: 27°C
		Min.	DB: 15°C
	Outdoor	Max.	DB: 21°C WB: 15°C
		Min.	DB: -15°C

Contents

Parts and Functions.....	1
Safety	2
Maintenance	5
Fault Checkup	6
Installation Procedures	7
Electrical Wiring.....	12
Test Run & Failure Code	18
Move and scrap the air conditioning.....	19

Warning

- If the supply cord is damaged, it must be replaced by the manufacturer, its service agent or similarly qualified persons in order to avoid a hazard.
- This appliance is not intended for use by persons (including children) with reduced physical, sensory or mental capabilities, or lack of experience and knowledge, unless they have been given supervision or instruction concerning use of the appliance by a person responsible for their safety.
- Children should be supervised to ensure that they do not play with the appliance.
- This appliance can be used by children aged from 8 years and above and persons with reduced physical, sensory or mental capabilities or lack of experience and knowledge if they have been given supervision or instruction concerning use of the appliance in a safe way and understand the hazards involved. Children shall not play with the appliance. Cleaning and user maintenance shall not be made by children without supervision.
- The appliances are not intended to be operated by means of an external timer or separate remote-control system.
- Keep the appliance and its cord out of reach of children less than 8 years.

Parts and Functions

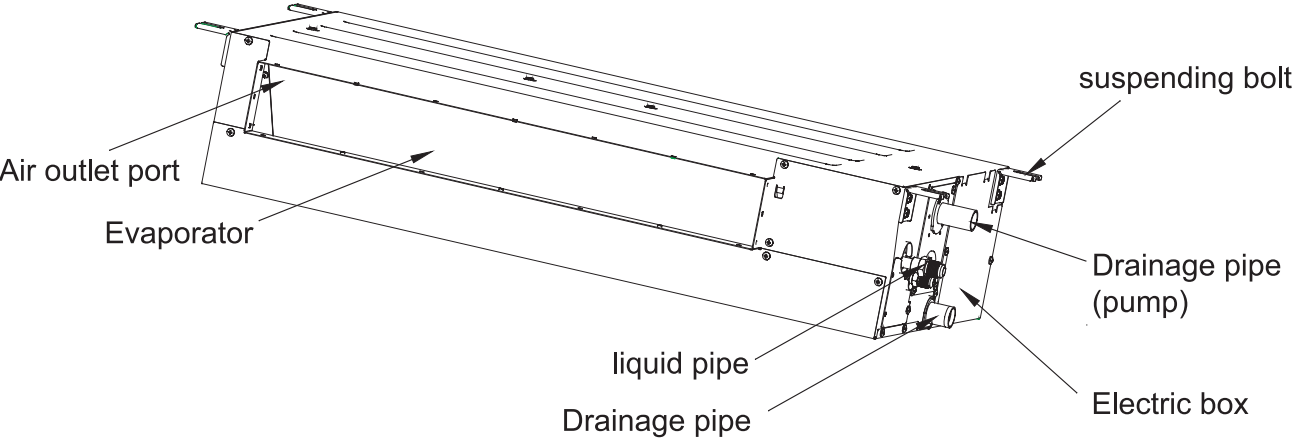

Safety

- This manual should always be accessible and close to this air condition equipment.
- There are two types of indications, "⚠ WARNING" and "⚠ CAUTION". The indication preventing from death or heavy injury is listed as "⚠ WARNING". Even the indication listed as "⚠ CAUTION" may also cause serious accident. Both of them are related to safety, and should be strictly followed.
- After installation and start-up commissioning, please handover the manual to the user. The manual should be well kept in safe place and close to the unit.

⚠ Warning

- The installation or the maintenance should be performed by an authorized agency. The wrong operation of this air condition equipment may cause water leakage, electric shock or fire.
- Please install the unit on the top of a solid foundation or structure which is strong enough to support the unit.
- The installation of this condition equipment should follow local construction codes.
- Use the right cable size, secure the terminal firmly, organize the cables well and make sure no tension is added on cables. Cable insulation should not be damaged. The incorrect installation may lead to overheat or fire.
- When installing or moving the unit, the refrigerant system should be vacuumed and recharged with R-410A refrigerant. If any other gas enters the system, it may lead to abnormal high pressure which may cause damage or injury.
- Please use the proper manifolds or branches during the system installation. The wrong parts may cause refrigerant leakage.
- Keep the drain pipe away from toxic gas vents to prevent possible pollution of indoor environment.
- During or after the installation, please check whether there is refrigerant leakage. If any leakage, please take any measures for ventilation. The refrigerant may be toxic at some concentration levels.
- The unit is not explosion-proof. Please keep it away from flammable gases.
- The drain pipe should be installed per this manual to ensure proper drainage. The pipe should be well insulated to avoid condensation. Wrong installation may lead to water leakage.
- Both liquid pipe and the gas pipe should be also well insulated. Not enough insulation may lead to system performance deterioration or humidity formation.
- This air condition equipment is not intended to be operated by persons with lack of experience and training, unless they have supervision or instruction concerning use of this air condition equipment.
- Please keep children away from this air condition equipment.
- This appliance is intended to be used by expert or trained users in shops, in light industry and on farms, or for commercial use by lay persons.
- Disconnect the appliance from its power source during service and when replacing parts.

Safety

Attention

- Grounding wire should be connected with the grounding bar. The grounding wire can not be connected to the gas pipe, water pipe, lightning rod or the telephone grounding wire. Improper grounding may cause electric shock.
- The Circuit Breaker should be installed. If not, it may cause electric shocks.
- After installation, the air condition equipment should be powered on and passed the electric leakage current test.
- Do not operate UV-C lamps outside of the appliance.
- Appliances that are obviously damaged must not be operated.
- If the UV-C lamp is damaged, it must be replaced by the manufacturer, its service agent or similarly qualified persons in order to avoid a hazard.
- The appliance must be disconnected from the power supply before replacing or cleaning or other maintenance of the UV-C lamp.
- Read the maintenance instructions before opening the appliance.
- Unintended use of the appliance or damage to the housing may result in the escape of dangerous UV-C radiation. UV-C radiation may, even in little doses, cause harm to the eyes and skin.

Safety

⚠ Attention

Notices during Operation

- Do not put any heating apparatus under the indoor units. The heat may cause distortion of the units.

- Pay attention to the ventilation to avoid anoxic injury.  

- Do not put burning apparatus in the place which the unit blows directly. There is risk of fire or anoxic injury.



- Ensure the installation area does not deteriorate with age. If the base collapses, the unit may fall and cause damage, product failure, personal injury or death. 

- Do not use the unit for special purposes such as preserving foods, works of art etc. It is an air conditioner for comfort cooling / heating, not a precision refrigeration system. 

- Use the correctly rated breaker or fuse. Improper breaker or fuse may lead to fire, electric shock, explosion, personal injury or death. 

- Do not permit water or steam to enter the unit and the wired controller. There is risk of unit failure, fire, electric shock, personal injury or death. 

- Turn on the power at least 6 hours before operation begins. Starting operation immediately after power on can result in severe damage to internal parts.

- Turn off the power to save energy if the unit will be not used for a long period. If the unit is not powered off, it will consume power.

- 3-minutes protection

To protect the unit, compressor can be actuated with at least 3-minutes delay after stopping.

- Close the window to avoid outdoor air getting in. Curtains or window shutters can be put down to avoid the sunshine. 

- Do not touch the power switch with the wet hand to avoid power shock. 

- Stop running and switch off the manual power switch when cleaning the unit. 

- During the unit operation, don't switch off the manual power switch. 

- Do not press the liquid crystal zone of controller to prevent damage. 

- Do not clean the unit with water spray. There is risk of unit failure, fire, electric shock, personal injury or death.



- Keep flammable gas or combustibles away from the unit. There is risk of product failure, fire, personal injury or death. 

- The unit is not intended to be operated by persons with lack of experience and training, unless they have supervision or instruction concerning use of this air condition equipment.

- Please keep children away from this air condition equipment.

- This appliance contains a UV-C lamp. 

Maintenance

Clean the air cleaner & air inlet grid.

- Don't dismantle the air cleaner if not cleaning, or faults might be caused.
- When the air conditioner operates in the environment with too much dust, clean the air conditioner more times (generally once every two weeks).

Cleaning the air outlet port and the shell:

⚠ Attention

- Don't use gasoline, benzene, diluents, polishing powder or liquid insecticide to clean them.
- Do not clean them with hot water of above 50°C to avoid fading or distorting.
- Wipe them with soft dry cloth.
- Water or neutral dry cleanser is recommended if the dust cannot be removed.
- The Wind Deflector can be dismantled to clean (as below).

Cleaning Wind Deflector:

- Do not wipe the wind deflector with water forcibly to avoid falling off.

Cleaning Air Cleaner:

⚠ Attention

- Don't rinse the air cleaner with hot water of above 50°C to avoid fading and distorting.
- Don't put the air cleaner on the fire to dry to avoid catching fire.

- Wipe dust with water or dust collector.
(A) Wipe dust with dust collector.



- (B) Clean it with soft brush in mild detergent if there is too much dust on it

- (C) Throw off the water and airing it in the cool dry condition.



Maintenance before and after Operating Season

Before Operating Season:

1. Please make the following checkup. If abnormal condition occurs, consult the after-service personnel.
 - There is no blockage in inlet port and outlet port of outdoor and indoor units.
 - The ground line and the wiring are in the proper state
2. After cleaning, the air cleaner must be mounted.
3. Switch on to the power.

After Operating Season:

1. In sunny days, blowing operation can be performed for half a day to make the inside of machine dry.
2. Electrical power should be cut down to economize electricity, or the machine will still consume power. Air cleaner and shell must be mounted after cleaning.

Fault Checkup

Please check the following when consigning repair service:

	Symptoms	Reasons
All these are not problems	<ul style="list-style-type: none"> Water flow sound 	Water flow sound can be heard when starting operation, during operation or immediately after stopping operation. When it starts to work for 2-3 minutes, the sound may become louder, which is the flowing sound of refrigerant or the draining sound of condensed water.
	<ul style="list-style-type: none"> Cracking sound 	During operation, the air conditioner may make the cracking sound, which is caused from the temperature changes or the slight dilation of heat exchanger.
	<ul style="list-style-type: none"> Terrible smell in outlet air 	During operation, the air conditioner may make the cracking sound, which is caused from the temperature changes or the slight dilation of heat exchanger.
	<ul style="list-style-type: none"> Flashing operating indicator 	When switching it on again after power failure, turn on the manual power switch and the operating indicator flashes.
	<ul style="list-style-type: none"> Awaiting indication 	It displays the awaiting indication as it fails to perform refrigerating operation while other indoor units are in heating operation. When the operator set it to the refrigerating or heating mode and the operation is opposite to the setting, it displays the awaiting indication.
	<ul style="list-style-type: none"> Sound in shutdown indoor unit or white steam or cold air 	To prevent oil and refrigerant from blocking the shutdown indoor units, refrigerant flows in the short time and make the sounds of refrigerant flowing. Otherwise, when other indoor units performs heating operation, white steam may occur; during refrigerating operation, cold air may appear.
	<ul style="list-style-type: none"> Clicking sound when switching the air condition on 	When the conditioner is powered on, the sound is made due to the resetting of the expansion valve.
Please make another check.	<ul style="list-style-type: none"> Start or stop working automatically 	Check if it is in the state of Timer-ON and Timer-OFF.
	<ul style="list-style-type: none"> Failure to work 	Check if there is a power failure. Check if the manual power switch is turned off. Check if the supply fuse and breaker are disconnected. Check if the protective unit is working. Check if refrigerating and heating functions are selected simultaneously with the awaiting indication on line control.
	<ul style="list-style-type: none"> Bad cooling & heating effects 	Check if air intake port and air outlet port of outdoor units are blocked. Check if the door and windows are open. Check if the filtering screen of air cleaner is blocked with sludge or dust. Check if the setting of wind quantity is at low wind. Check if the setting of operation is at the Fan Operation state. Check if the temperature setting is proper.

Under the following circumstances, immediately stop the operation, disconnect the manual supply switch and contact the after-service personnel.

- When buttons are inflexible actuated;
- When there are foreign objects and water in the refrigerator;
- When it cannot still be operated after removing the operation of protective unit;
- When other abnormal conditions occur.

Installation Procedures

This manual cannot completely illustrate all the properties of the products you bought. Please contact the local Haier distribution center if you have any question or request.

Please use the standard tools according to the installation requirements.

The standard attached accessories of the units of this series refer to the packing list; prepare other accessories according to the requirements of the local installation point of our company.

1. Choose the suitable installation location. Indoor units should be installed in places with the environment of even circulation of cool and warm blows. The following places should be avoided.

Places with high salinity (beach), high sulfureted gas (such as the thermal spring regions where copper tubes and soft soldering are easy to be eroded), much oil (including mechanical oil) and steam; places where organic substance solvent is frequently used; places where machines generate the high frequency electromagnetic wave (abnormal condition will appear in the control system); places where there is high humidity exists near the door or windows (dew is easily formed); and places where the special sprayer is frequently used.

Indoor Units

1. The distance between wind outlet port and the ground should not be more than 2.7m.
2. Select appropriate places for installation where the outlet air can be spread to places all over the house and arrange proper locations for connecting pipes and lines as well as the drainpipe to the outdoor.
3. Ceiling construction must be hard enough to hold the weight of the unit.
4. Make sure that the connecting pipe, the drainpipe and connecting guide line can be put into walls to connect the outdoor units.
5. It is recommended to make the connecting pipe between the outdoor and indoor units and the drainpipe are as short as possible.
6. Please read the attached installation instruction of outdoor units for regulation of filling amount of refrigerant if necessary.
7. The connecting flange should be checked by users.
8. Those electrical appliances such as television, instruments, devices, artwork, piano, wireless equipment and other valuables should not be placed under the indoor unit as to prevent condensate from dropping into them and causing damage.

2. The following steps can be taken after selecting the installation place:

- (1) Cut a hole in the wall and insert connection pipe and connecting wires through a locally purchased PVC pipe. The hole should be inclined slightly downward with an inclination of at least 1/100 (see Figure 1).
- (2) Before cutting the hole, ensure no pipe or rebar is placed behind the cutting position. Avoid cutting a hole at the place of wires or connection pipes.
- (3) Hang the unit on a horizontal and firm roof. If the unit base is not stable, it may cause noise, vibration or leakage.
- (4) Support the unit firmly and change the shapes of connection pipe, connecting wires and drain pipe to make them easily get through the hole.

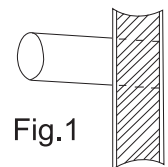
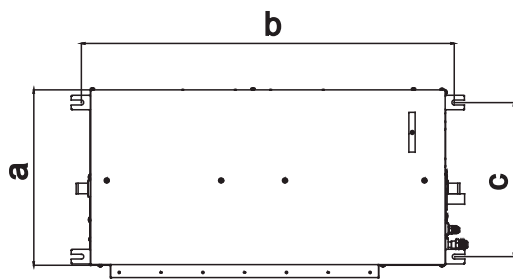

Fig.1

3. Dimension (unit: mm).

Model	a	b	c	d	e	f	g	h	i
AD052~162MSERA(H)	420	892	370	850	185	640	90	760	152
AD182~242MSERA(H)	420	1212	370	1170	185	960	90	1080	152

Installation Procedures



Hanger dimensions

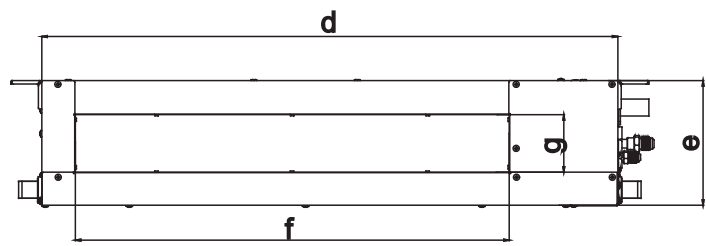

Dimensions of air outlet

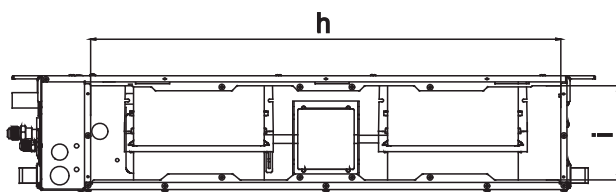

Dimensions of return air inlet

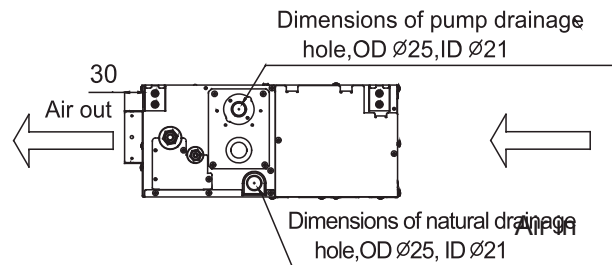

Dimensions of drain hose

Installation modes of Indoor unit

This series of air conditioners can be arranged in two air return modes: 1. backward air return (factory default); 2. downward air return (can be adjusted on site. See the following figures.)

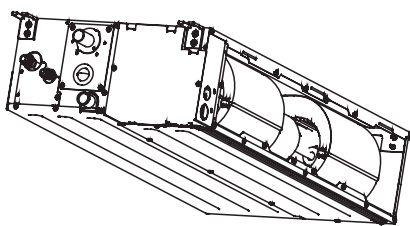

Backward air return

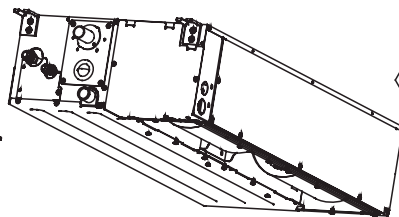

Downward air return 1

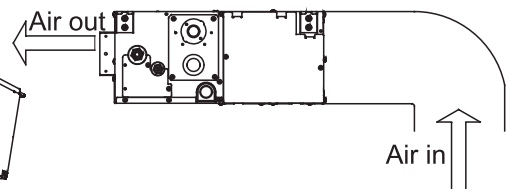

Downward air return 2

Note: the downward air return mode would increase noise 3-5dB(A). It is recommended to install the air conditioner in downward return air mode 2 if enough space is available.

Installation space and method

Body installation

1. Use M10 lifting bolts.
2. Ceiling removal: For different building structures, please consult with indoor decoration personnel about actual conditions.
 - a. Ceiling reinforcement: To ensure the ceiling is horizontal and will not shake, the ceiling base frame must be reinforced.
 - b. Cut off and remove the ceiling base frame.
 - c. Reinforce the end faces left when the ceiling is removed and further reinforce the base frame that fix both ends of the ceiling.
 - d. After the body installation is complete, it is time to install pipes and wires. Before installation, choose a suitable installation position and determine the outgoing direction of pipes. Especially in case that a ceiling exists, please pull refrigerant tubing, drain hose, indoor and outdoor connecting wires, control wires to their connection positions prior to hanging the machine.

Installation Procedures

Installation space:

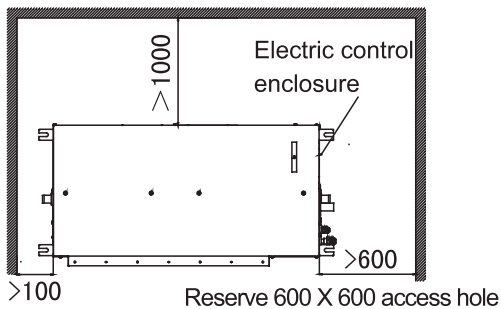

Installation mode:

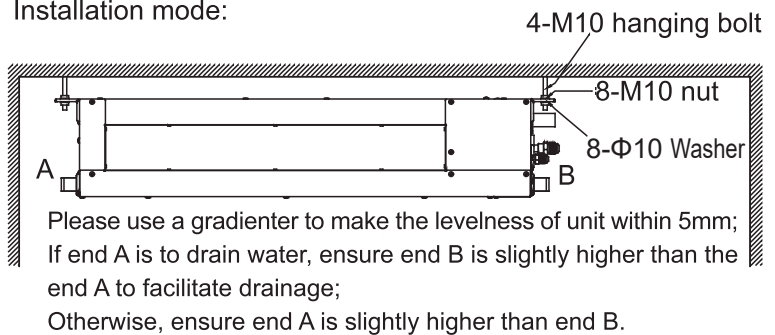

Installation of air-inlet grille

The angle of air-inlet grille should be parallel with that of air inlet direction, otherwise it will cause more noise. As shown in the figure on the right.

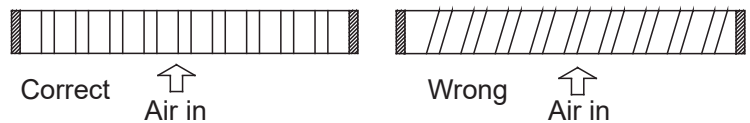

Installation of Duct Pipe of Indoor Units:

1. Installation of the air blowing pipe:

With a square blast pipe, the bore shouldn't be less than the sizes of air outlet pipe.

2. Installation of the air return pipe: Connect one side of the air return pipes to the air return port of the indoor units with rivets, with the other side connected to air return shutter, as shown in Fig. 1.

3. Heat Preservation of Blast Pipes: Heat preservation lays should be provided for air blowing & return pipes. Paste glue nails on the blast pipes and attach thermo wool, which covered by a layer of silver paper, fix it with glue nail cover, and then seal the joint with silver paper.

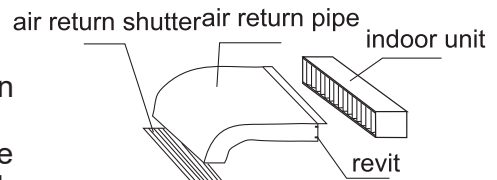

Fig.1
connection of oil return pipe

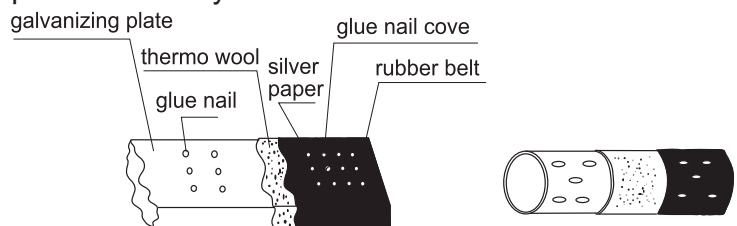

Fig.2

Selection of fan outlet

This machine uses a DC motor, by which multi-range ESP adjustment is available. The factory default is standard ESP. The ESP & Silent mode can be set according to the pipe resistance and the silence requirement. Setting ranges are as follows:

Model	Ultra-silent	Silent	Standard ESP default	High ESP	Super high ESP
Grade	1	2	3	4	5

Operation:

When the YR-E17 wired controller is on and the screensaver is off, press the wind speed key & function key together for 5 seconds to get into the ESP adjustment mode. When the grade number is flashing, press "up" and "down" to change, then press the function key to set.

Remote controller: Set temperature of 16°C and press "light" button on remote controller 8 times in 10 seconds, and you hear 2 times beep, then adjusting the temperature to 17 °C, press the button off, then you can hear 1 times beep, it means grade 1 (Ultra-silent) is set successfully, and so on, no action within two minutes, it will automatically exit the function setting.

Note:

This series are low ESP duct, all the sets above must be handled by YR-E17 or remote controller controller after asking our after-sales staff according to the the installation condition at site. For more details, please see the YR-E17(upgraded) installation instructions.

Installation Procedures

Installation of drain hose

Connection of indoor drain hose

1. Please use accessory drain hose to connect indoor unit's water outlet and PVC pipe and use snap rings to tighten them, as shown in the following figure:
2. Please use rigid PVC adhesive for connection of other pipes and ensure there is no leakage.
3. Drain hose must be wrapped up with insulation sleeve and tightened with strap to prevent air leaked in producing condensate.
4. To prevent water flowing back into air conditioner when the it stops running, drain hose shall decline to the drainage side with a declination of above 1/100. Drain hose expansion or water accumulation shall be prevented, or else it will cause abnormal noise.
5. When connecting the drain hose, do not pull on it so as to avoid the pipe connections getting loose or off. Drain hose should not be pulled out laterally for more than 20cm and should be supported every 0.8-1.0m to avoid bending.
6. The end of drain hose should be more than 50mm away from the ground or the bottom of drainage tank. It should not be put in water. To directly drain condensate into drainage ditch, the drain hose should be U-shaped to avoid stink spreading through the hose into room.

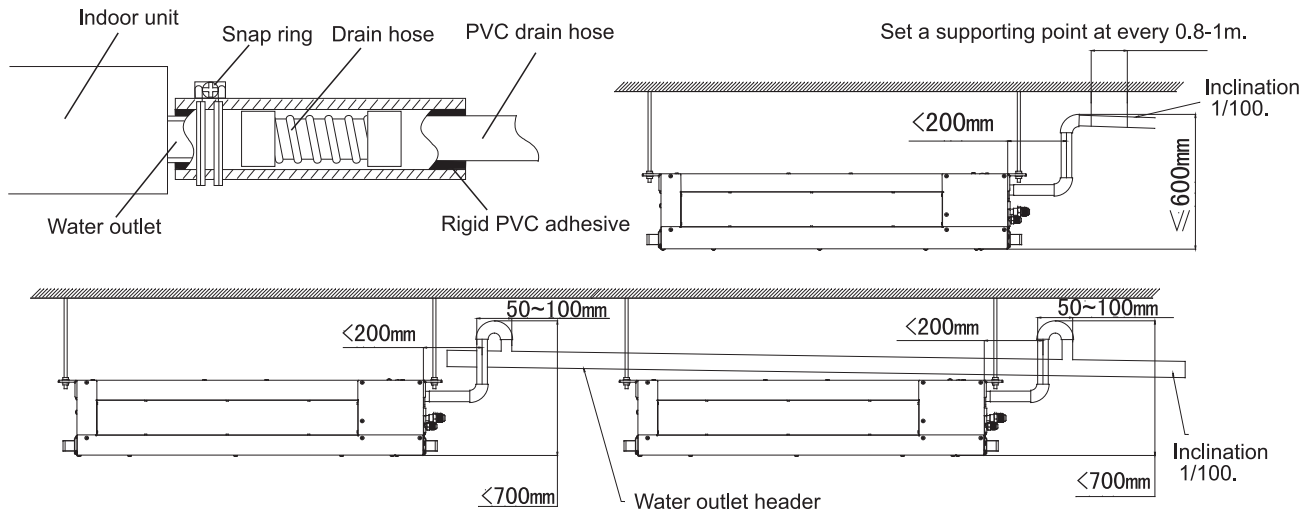

Multiple units use water outlet header to drain water into drainage ditch.

Drainage test

Before test, firstly ensure the drain hose is unblocked and all connections are tightly sealed and then perform the drainage test as follows:

1. Inject about 500ml water into the water pan through water injection hole;
2. Switch on the power and make air conditioner operate in refrigerating mode. Check whether the water outlet drains water normally and there are no leakages on connections. After the drainage test is complete, replace the water injection hole plug. For the position of water injection hole, see the figure on the right:

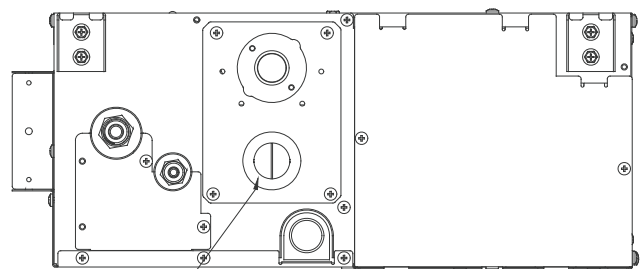

Open or close the water injection hole by rotating the hole plug

Installation Procedures

Pipe Length & Height Difference

Please refer to the attached manual of outdoor units.

Tubing Materials & Specifications

Special tools for R410A should be used for cutting and enlarging pipes.

Model		AD052~092 MSERA(H)	AD122~182 MSERA(H)	AD242 MSERA(H)
Tubing Size(mm)	Gas pipe	Ø9.52	Ø12.7	Ø15.88
	Liquid pipe	Ø6.35	Ø6.35	Ø9.52
Tubing Material	Phosphor deoxybronze seamless pipe (TP ₂) for air conditioner			

Refrigerant Recharge Amount

Add the refrigerant according to the installation instruction of outdoor unit. The addition of R410A refrigerant must be performed with a measure gage to ensure the specified amount while compressor failure can be caused by filling too much or little refrigerant.

Connecting Procedures of Refrigerant Tubing

With the soft solder, the nitrogen-filling protection should be used.

Cutting and Enlarging

Cutting or enlarging pipes should be proceeded by installation personnel according to the operating criterion if the tube is too long or flare opening is broken.

Vacuumizing

Vacuumize from the stop valve of outdoor units with vacuum pump. Refrigerant sealed in indoor machine is not allowed to use for vacuumization. Vacuum pump with check valve should be used for vacuumizing to prevent pump oil flowing into the machine.

Open All Valves

Open all the valves of outdoor units. [NB: oil balancing stop valve must be shut up completely when only connected one main unit.]

Checkup for Air Leakage

Check if there is any leakage at the connecting part and bonnet with hydrophone or soapsuds.

Connecting

1. Connecting circular terminals:

The connecting method of circular terminal is shown in the Fig. Take off the screw, connect it to the terminal tier after heading it through the ring at the end of the lead and then tighten it.

2. Connecting straight terminals:

The connection methods for the circular terminals are shown as follows: loosen the screw before putting the line terminal into the terminal tier, tighten the screw and confirm it has been clamped by pulling the line gently.

3. Pressing connecting line

After connecting line is completed, press the connecting line with clips which should press on the protective sleeve of the connecting line.

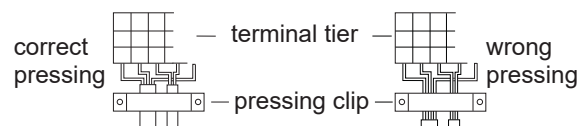

Electrical Wiring

⚠ Warning

- Electrical construction should be made with specific mains circuit by the qualified personnel according to the installation instruction. Electric shock and fire may be caused if the capacity of power supply is not sufficient. !
- During arranging the wiring layout, specified cables should be used as the mains line, which accords with the local regulations on wiring. Connecting and fastening should be performed reliably to avoid the external force of cables from transmitting to the terminals. Improper connection or fastness may lead to burning or fire accidents. !
- There must be the ground connection according to the criterion. Unreliable grounding may cause electrical shocks. Do not connect the grounding line to the gas pipe, water pipe, lightning rod and telephone line. !

⚠ Attention

- Only copper wire can be used. Breaker for electric leakage should be provided, or electric shock may occur.
- The wiring of the mains line is of Y type. The power plug L should be connected to the live wire and plug N connected to null wire while \oplus should be connected to the ground wire. For the type with auxiliary electrically heating function, the live wire and the null wire should not be misconnected, or the surface of electrical heating body will be electrified. If the power line is damaged, replace it by the professional personnel of the manufacturer or service center.
- The power line of indoor units should be arranged according to the installation instruction of indoor units.
- The electrical wiring should be out of contact with the high-temperature sections of tubing as to avoid melting the insulating layer of cables, which may cause accidents.
- After connected to the terminal tier, the tubing should be curved into be a U-type elbow and fastened with the pressing clip. !
- Controller wiring and refrigerant tubing can be arranged and fixed together.
- The machine can't be powered on before electrical operation. Maintenance should be done while the power is shut down.
- Seal the thread hole with heat insulating materials to avoid condensation.
- The power cord should be H05VV-F, 3G 1.0-1.5mm².
- The communication interconnection cord between indoor unit and outdoor unit should be at least H05RN-F, 2×0.75mm².
- 5 butt lines (1.5mm) are equipped in the machine before delivery, which are used in connection between the valve box and the electrical system of the machine. The detailed connection is displayed in the circuit diagram.
- If the fuse on the indoor PC board is broken please change it with the type of T 5A /250VAC.

Supply Wiring Drawing

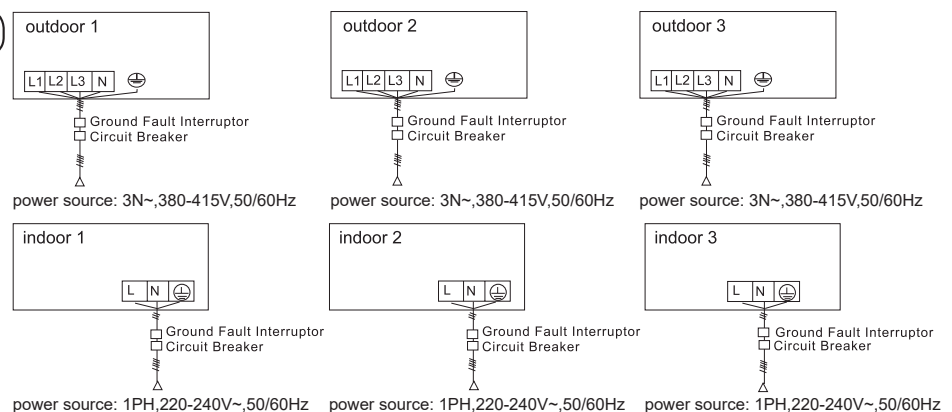

- Indoor units and outdoor units should be connected to the power source separately. Indoor units must share one single electrical source, but its capacity and specifications should be calculated. Indoor & outdoor units should be equipped with the power leakage breaker and the overflow breaker.

Electrical Wiring

Signal Wiring Drawing

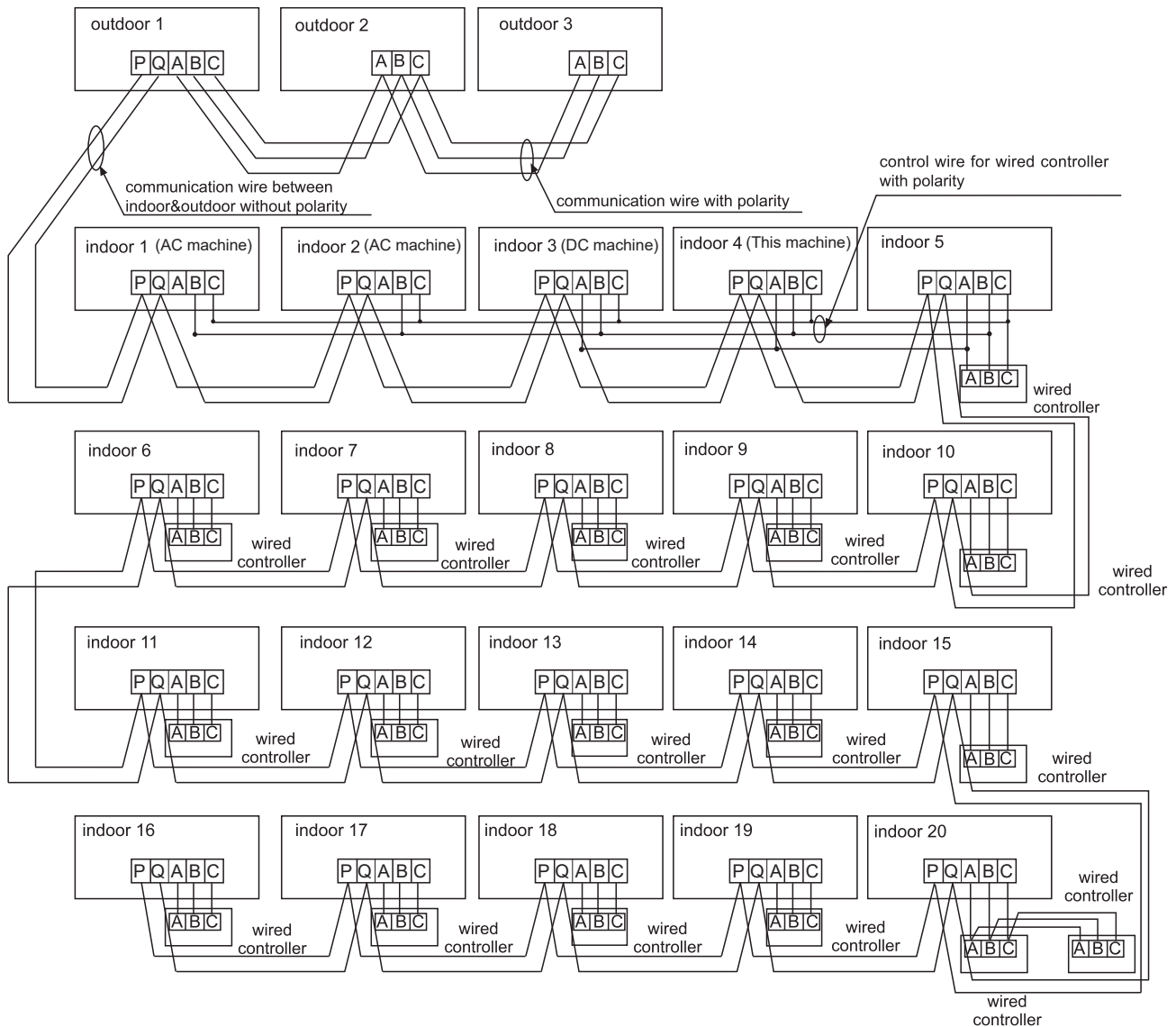

Outdoor units are of parallel connection via three lines with polarity. The main unit, central control and all indoor units are of parallel connection via two lines without polarity.

There are three connecting ways between line control and indoor units:

- A. One line control controls multiple units, i.e. 2-16 indoor units, as shown in the above figure, (1-5 indoor units). The indoor unit 5 is the line-controlled main unit (directly connected to the indoor unit of line control) and others are the line-controlled sub units. Among them, the 4 indoor unit is this unit, the 3 indoor unit is the other DC models, 1 indoor unit and 2 indoor unit are the AC models. The line control device is connected with the line-controlled main unit and DC models through three lines with polarity. Other indoor units and the main unit are connected via two lines with polarity. SW01 on the main unit of line control is set to 0 while SW01 on other sub units of line control are set to 1, 2, 3 and so on in turn. (Please refer to the code setting)
- B. One line control controls one indoor unit, as shown in the above figure (indoor unit 6-19). The indoor unit and the line control are connected via three lines with polarity.

Electrical Wiring

C. Two line controls control one indoor unit, as shown in the figure (indoor unit 20). Either of the line controls can be set to be the master line control while the other is set to be the auxiliary line control. The master line control and indoor units, and the master and auxiliary line controls are connected via three lines with polarity.

When the indoor units are controlled by the remote control, switch over the modes by Switching Mode of Line-Controlled Main Unit/ Line-Controlled Sub Units/ Remote-Controlled Types. The signal terminals needn't to be equipped with wires and connected to the line control.

Note: For DC motor low ESP duct, the PCB comes with the terminal Blocks. Please be sure to pay attention to do the wiring according to the identification. The Power lines and Singal lines go through the metal wire hole separately with the protective sleeve of the connecting line.

Indoor power supply wiring & signal wiring between indoor and outdoor & signal wiring between indoors.

Items Total Current of Indoor Units(A)	Cross Section (mm ²)	Length (m)	Rated Current of Overflow Breaker(A)	Rated current of residual Circuit Breaker(A) Ground Fault Interruptor(mA) Response time(S)	Cross Sectional Area of Signal Line	
					Outdoor -indoor (mm ²)	Indoor -indoor (mm ²)
<6	2.5	20	6	6A,30mA,0.1S or below	2 cores×0.75-2.0 mm ² shielded lin	
≥6 and <10	2.5	20	10	10A,30mA,0.1S or below		
≥10 and <16	4	25	16	16A,30mA,0.1S or below		
≥16 and <25	6	30	25	25A,30mA,0.1S or below		
≥25 and <32	10	50	32	32A,30mA,0.1S or below		

- The electrical power line and signal lines must be fastened tightly.
- Every indoor unit must have the ground connection.
- The power line should be enlarged if it exceeds the permissible length.
- Shielded lays of all the indoor and outdoor units should be connected together, with the shielded lay at the side of signal lines of outdoor units grounded at one point.
- It is not permissible if the whole length of signal line exceeds 1000m.

Signal Wiring of Wired controller

Length of Signal Line (m)	Wiring Dimensions
≤250	0.75mm ² x core shielding line

- The shielding lay of the signal line must be grounded at one end.
- The total length of the signal line shall not be more than 250m.

Electrical Wiring

Dipswitch Setting

- The dipswitch is dialed to "On" position with the overline at the state of strapping if the code or overline status is "1" The dipswitch is dialed to "Off"position with the overline at the state of disconnection if the code or overline status is "0"
- In the table below, the choice in the box "□" refers to the setting of the socket/overline before delivery.

Indoor Units PCB

In the following table, 1 represents On and 0 represents Off.

Definition principles of code switches:

SW01 is used to set wire controlled address of and set capabilities of master;SW03 is used to set indoor unit address (combine original communication address and address of centralized controller)

(A) Definition and description of SW01

SW01_1 SW01_2 SW01_3 SW01_4	Address of wire controlled indoor unit (group address)	[1]	[2]	[3]	[4]	Address of wire controlled indoor unit (group address)
		0	0	0	0	0
		0	0	0	1	1# (wire controlled slave unit)
		0	0	1	1	2# (wire controlled slave unit)
		0	0	1	1	3# (wire controlled slave unit)
	
		1	1	1	1	15# (wire controlled slave unit)
SW01_5 SW01_6 SW01_7 SW01_8	Capability of indoor unit	[5]	[6]	[7]	[8]	Capability of indoor unit
		0	0	0	0	0.6HP
		0	0	0	1	0.8HP
		0	0	1	0	1.0HP
		0	0	1	1	1.2HP
		0	1	0	0	1.5HP
		0	1	0	1	1.7HP
		0	1	1	0	2.0HP
		0	1	1	1	2.5HP
		1	0	0	0	3.0HP
		1	0	0	1	3.2HP
		1	0	1	0	4.0HP
		1	0	1	1	5.0HP
		1	1	0	0	6.0HP
		1	1	0	1	8.0HP
1	1	1	0	10.0HP		
1	1	1	1	15.0HP		

Note : A wired controller can connected to at most sixteen ultrathin air-duct indoor units.

Electrical Wiring

(B) Definition and description of SW03

SW03_1	Address setting mode	0	Automatic address setting or wired controller address setting (default)								
		1	Code-set address								
SW03_2 ~ SW03_8	Code-set indoor unit address and centralized controller address (Note 2)	2	3	4	5	6	7	8	Address of indoor unit	Address of centralized controller	
		0	0	0	0	0	0	0	0	0# (Default)	0# (Default)
		0	0	0	0	0	0	0	1	1#	1#
		0	0	0	0	0	0	1	0	2#	2#
	
		0	1	1	1	1	1	1	1	63#	63#
		1	0	0	0	0	0	0	0	0#	64#
		1	0	0	0	0	0	0	1	1#	65#
		1	0	0	0	0	0	1	0	2#	66#
	
		1	1	1	1	1	1	1	1	63#	127#

Note 2:

•Set the address by code when connecting the centralized controller or gateway or charge system.

•Address of centralized controller =communication address + 0 or +64.

SW03_2=OFF, address of centralized controller =communication address+0=communication address

SW03_2=ON, address of centralized controller=communication address+64 (applies when centralized controller is used and there are more than 64 indoor units)

•To use with 0010451181A in use, it is required to use code for address setting. Set SW03_1=0N and SW03_2=OFF; SW03_3, SW03_4, SW03_5, SW03_6, SW03_7 and SW03_8 are address codes which are set according to actual address.

(C) Jumper definition description

Electronic expansion valve PMV manual control settings(CN27、CN29)

Manually fully open CN27: short circuit CN27 for 2 seconds after power, the PMV fully opened.

Manually fully close CN29: short circuit CN29 for 2 seconds after power, the PMV fully closed.

26°C Lock function Activation:

Default: Deactivated

Activation: Press "Health" button on remote controller 8 times in 5 seconds, and you hear 4 times beep, then activate the function.

Deactivation: Press "Health" button on remote controller 8 times in 5 seconds, and you hear 2 times beep, then deactivate the function.

Electrical Wiring

Code setting of wired controller

Function switches

DIP switch	On/Off station	Function	Default setting
Sw1	On	Slave wired controller	Off
	Off	Master wired controller	
Sw2	On	Ambient temp. display on	Off
	Off	Ambient temp. display off	
Sw3	On	Collect ambient temp. from PCB of indoor	Off
	Off	Collect ambient Temp. from wired controller	
Sw4	On	Non-volatile memory invalid	Off
	Off	Non-volatile memory valid	
Sw5	On	Old protocol	Off
	Off	Selfadaption	
Sw6	On	reserved	Off
	Off	reserved	
Sw7	On	Model with Up/Down and Left/Right swing	Off
	Off	Model with Up/Down swing	
Sw8	On	Fresh Air unit	Off
	Off	General unit	

Note: Note: On indicates short circuit; Off indicates disconnection.

The above content is for YR-E17 wired remote controller DIP, for other wired remote controller's dial code, please refer to their own manual.

The difference between master and slave wired controller

Comparison item	Master wired controller	Slave wired controller
Function	All function	<ol style="list-style-type: none"> 1.ON/OFF, Mode, Fan speed, Temp,Setting, Swing,Energy saving, Clock function,Mode Setting,Screen Saving and Child lock are available; 2. Cancel the filter cleaning icon. 3. Look up the detailed parameter and malfunction code.

Test Run & Failure Code

Before Test Run

- Before switching it on, test the supply terminal tier (L, N terminals) and grounding points with 500V megaohm meter and check if the resistance is above 1MΩ. It can't be operated if it is below 1MΩ.
- Connect it to the power supply of outdoor units to energize the heating belt of the compressor. To protect the compressor at startup, power it on 12 hours prior to the operation.

Check if the arrangements of the drainpipe and connection line are correct.

The drainpipe shall be placed at the lower part while the connection line placed at the upper part. Heat preservation measures should be taken such as winding the drainpipe esp. in the indoor units with heating insulating materials.

The drain pipe should be made a slope type to avoid protruding at the upper part and concaving at the lower part on the way.

Checkup of Installation

- | | |
|---|--|
| <input type="checkbox"/> check if the mains voltage is matching | <input type="checkbox"/> check if the installation place meets the requirement |
| <input type="checkbox"/> check if there is air leakage at the piping joints | <input type="checkbox"/> check if there is too much noise |
| <input type="checkbox"/> check if the connections of mains power and indoor & outdoor units are correct | <input type="checkbox"/> check if the connecting line is fastened |
| <input type="checkbox"/> check if the serial numbers of terminals are matching | <input type="checkbox"/> check if the connectors for tubing are heat insulated |
| | <input type="checkbox"/> check if the water is drained to the outside |
| | <input type="checkbox"/> check if the indoor units are positioned |

Ways of Test Run

Do ask the installation personnel to make a test run. Take the testing procedures according to the manual and check if the temperature regulator works properly.

When the machine fails to start due to the room temperature, the following procedures can be taken to do the compulsive running. The function is not provided for the type with remote control.

- Set the YR-E17 wired controller to cooling/heating mode, press "ON/OFF" button for 10 seconds to enter into the compulsive cooling/heating mode. Repress "ON/OFF" button to quit the compulsive running and stop the operation of the air conditioner.

Fault Remedies

When any fault appears, consult the fault code of line control or the flashing times for LED5 of computer panel of indoor units/health lamp of receiving window of remote control and find out the faults as shown in the following table to remove all faults.

Indoor Unit Faults

Failure code at wired controller	PCB LED5(Indoor Units)/ Receiver Timer Lamp(Remote Controller)	Fault Descriptions
01	1	Fault of indoor unit ambient temp. transducer TA
02	2	Fault of indoor unit pipe temp. transducer TC1
03	3	Fault of indoor unit pipe temp. transducer TC2
04	4	Fault of indoor unit dual heat source temp. transducer
05	5	Fault of indoor unit EEPROM
06	6	Fault of communication between indoor & outdoor units
07	7	Fault of communication between indoor unit and wired control
08	8	Fault of indoor unit float switch
09	9	Fault of duplicate indoor unit address
12	12	Fault of indoor unit 50Hz Zero-crossing
14	14	Fault of indoor unit DC motor
18	18	BS valve box or 4WV switch failure
20	20	Corresponding faults of outdoor units

Move and scrap the air conditioning

- When moving, to disassemble and re-install the air conditioning, please contact your dealer for technical support.
- In the composition material of air conditioning, the content of lead, mercury, hexavalent chromium, polybrominated biphenyls and polybrominated diphenyl ethers are not more than 0.1% (mass fraction) and cadmium is not more than 0.01% (mass fraction).
- Please recycle the refrigerant before scrapping, moving, setting and repairing the air conditioning; for the air conditioning scrapping, should be dealt with by the qualified enterprises.

